

Control of grid connected inverter system for sinusoidal current injection with improved performance

Simeen. S. Mujawar.

Electrical engineering Department, Pune University /PVG's COET, Pune, India.

simeen1990@gmail.com

Prof. Mrs. G. M. Karve

Department of Electrical Engineering, Pune University /PVG's COET, Pune, India.

gauri.m.karve@gmail.com

Abstract

The control strategy for the grid connected inverter (GCI) during abnormal conditions like voltage sag, swell and line to ground fault has been presented. The strategy adopted here operates even during faulty conditions, unlike the conventional controller which fails to operate during faulty conditions. The Multi-Reference Frame (MRF) PI Controller is used for this purpose. In order to study the Dynamic Performance of the system, it is simulated in Matlab Simulink environment. The overall system is simulated for normal condition that is without the presence of fault, and with the presence of fault. The performance is also studied during abnormal conditions of the grid and its results are analyzed. The simulation results exhibit improved performance of the system during normal as well as abnormal conditions.

Introduction

There has been a substantial increase of interest in distributed generation (DG), that is, generation of power dispersed throughout the power system. There are a number of power quality issues that must be addressed as a part of the overall inter-connection evaluation for DG. The advent of power electronic devices has put forth a new era for the maintenance of power quality as they efficiently interface renewable energy system to the grid. However, the asynchronous interface provided by the power electronic converter raises issues regarding power quality [1]. The power conversion unit basically consists of the source side and the grid side converters. The grid connected inverter control has taken the centre stage whenever we consider the improvement of Distributed Generation Systems (DGS). The inverter control consists of balancing the power between the input side converter and the grid, providing high output power quality and maintaining synchronization with the grid [2]. Based on recent studies, power quality is an important issue to meet the rising demand for energy. Voltage sag, voltage swell and other faults are the most frequent disturbances. This leads to the discontinuity of supply and the economic loss. Presence of low-order harmonics, voltage swell, voltage sag and line to ground fault represent the most common grid disturbances. A number of control strategies to mitigate the problems have been proposed and are extensively studied in the available literature [5, 8, and 9]. The main functions of the controllers are to maintain the power quality and to control the active and the reactive power of the grid independently. Various control strategies have been proposed and are extensively studied in the available literature [3]-[5]. Proper power flow regulation using vector control principle has also been proposed in [6]. Dual Vector Current control which was first proposed in [7] uses two VCC's for positive and negative sequence components along with DC link voltage control. Synchronous PI current control has also been proposed in [8] which convert the three phase grid voltages to synchronously rotating (d-q) frame for proper decoupling. The grid currents become DC variables and thus no steady state error adjustment is required. This paper presents the design of a current controller in order to ameliorate the power quality in the grid. This technique intends to overcome the hitches faced by the conventional controller working under unbalanced conditions of the grid. The control strategy adopted here counterbalances the distortions in grid voltage by injecting sinusoidal current to the grid through a MRF PI controller strategy. Comprehensive study of the multiple-reference frame (MRF) PI controller design is discussed [10]. The MRF PI controller doesn't need dq current signal high pass and low pass filtering and yet it injects nearly sinusoidal current to the grid in order to counteract with the distortions provides a reliable method for power quality improvement. The organization of the paper is as follows. Section II depicts the mathematical modelling of the Grid Connected Inverter (GCI)

System. Section III explains the control algorithm of the Grid Connected Inverter (GCI) along with detailed mathematical analysis. Section IV describes simulation results and controller performance. Section V concludes the paper followed by the references.

Mathematical modelling of grid connected inverter system

The schematic diagram of three phase grid-connected PWM inverter is shown in Fig. 1, which consists of dc link capacitor, IGBT switches and filter circuit in the grid side.

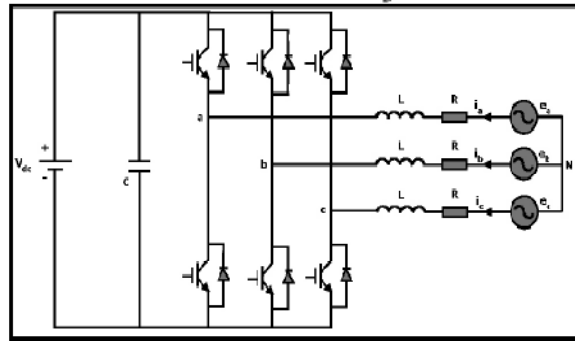

Fig. 1 Schematic diagram of Grid connected PWM Inverter

Assume that the three phase loop resistance R and L are of the same value, affection of distribution parameters are negligible and switching loss and on state voltage drop is negligible. Based on the topology, the dynamic equation of the output side of the grid connected inverter can be deduced as follows:

$$e_{abc}(t) - v_{abc}(t) = L \frac{di_{abc}(t)}{dt} + Ri_{abc}(t) \quad (1)$$

We can write the dynamic equation for the input side of the grid connected inverter as:

$$i_c(t) = i_{dc}(t) - i_L(t) = C \frac{dv_{dc}(t)}{dt} \quad (2)$$

The line voltages and the phase currents can be transformed into synchronous reference frame (dq co-ordinates) by the use of the transformation matrix

$$v_{dq}(t) = T v_{abc}(t) \quad (3)$$

$$[T] = \begin{bmatrix} \cos\theta & \sin\theta & 1 \\ \cos(\theta - \frac{2\pi}{3}) & \sin(\theta - \frac{2\pi}{3}) & 1 \\ \cos(\theta + \frac{2\pi}{3}) & \sin(\theta + \frac{2\pi}{3}) & 1 \end{bmatrix}$$

is the transformation matrix and θ is the rotating angle of transformation.

Now we can transform the dynamic equation directly into synchronous reference frame (dq co-ordinates)

By assuming that the three phase voltage source is balanced without the zero sequence components we can write

$$v_d(t) = e_d(t) - L \frac{di_d(t)}{dt} - Ri_d(t) + Li_q(t) \quad (5)$$

$$v_q(t) = e_q(t) - L \frac{di_q(t)}{dt} - Ri_q(t) + Li_d(t) \quad (6)$$

The s-domain representation can be shown as follows:

$$i_d(s) = \frac{1}{Ls + R} [e_d(s) - v_d(s) + Li_q(s)] \quad (7)$$

$$i_q(s) = \frac{1}{Ls + R} [e_q(s) - v_q(s) + Li_d(s)] \quad (8)$$

For the input side of the converter

$$V_{dc} = \left\{ \frac{R_l}{1 + CR_l s} \right\} i_{dc} \quad (9)$$

$$S(t) = E * I \quad (10)$$

$$= P(t) + jQ(t) \quad (11)$$

$$P = \frac{3}{2} \text{Re}[(E_d + jE_q)(I_d + jI_q)^*] \quad (12)$$

$$P(t) = \frac{3}{2} [e_d(t)i_d(t) + e_q(t)i_q(t)] \quad (13)$$

$$Q = \frac{3}{2} \text{Im}[(E_d + jE_q)(I_d + jI_q)] \quad (14)$$

$$Q(t) = \frac{3}{2} [e_q(t)i_d(t) - e_d(t)i_q(t)] \quad (15)$$

Control for Grid Connected Inverter

1) Current Controller

Conventional current controllers use only cross coupling and feed forward terms. It has been seen that even with certain modifications in the PLL structure, there is little improvement in the power quality, the main culprit being the lower order harmonics. It is seen that the distribution grid voltage is considerably distorted due to the presence of nonlinear loads. This leads to the presence of significant lower order harmonic content especially of 5th, 7th, 11th and 13th order.

$$V_a = V_1 \cos(\theta) + V_5 \cos(5\theta) + V_7 \cos(7\theta)$$

$$V_b = V_1 \cos\left(\theta - \frac{2\pi}{3}\right) + V_5 \cos\left(5\theta - \frac{2\pi}{3}\right) + V_7 \cos\left(7\theta - \frac{2\pi}{3}\right)$$

$$V_c = V_1 \cos\left(\theta + \frac{2\pi}{3}\right) + V_5 \cos\left(5\theta + \frac{2\pi}{3}\right) + V_7 \cos\left(7\theta + \frac{2\pi}{3}\right)$$

Transforming these into synchronously rotating reference frame we get

$$V_d = V_1 + (V_5 + V_7) \cos(6\theta) + (V_{11} + V_{13}) \cos(12\theta) + \dots$$

$$V_q = (-V_5 + V_7) \sin(6\theta) + (-V_{11} + V_{13}) \sin(12\theta) + \dots$$

In addition to these, there are other higher order harmonics present. However, we do not take them into consideration due to their low magnitudes in the system. Here it is seen that the d-q grid voltage components have basically frequency components which are multiples of six of the frequency of the grid.

During unbalance conditions such as voltage sags, presence of harmonics and fault conditions the conventional controller fails to provide the required sinusoidal grid current and voltage which degrades the power quality of the system.

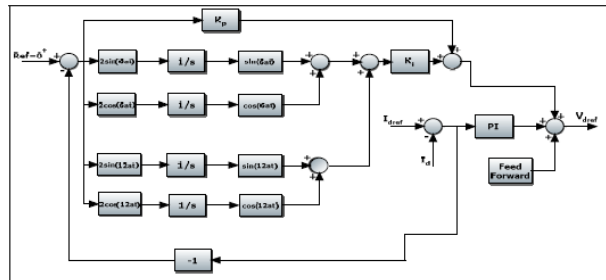

Fig. 2 MRF PI Current Controller structure

In order to mitigate lower order harmonics in the grid current, we require a modified current controller to ensure proper operation of the grid under distorted conditions. The use of multiple reference frame (MRF) PI controller is used here as shown in Fig. 2. The MRF PI controller doesn't extract harmonics from the current by the application of high-pass and low pass filter but injects a component antagonistic to the harmonics present in the same

2) Filter design

It is seen that the converter current is mostly plagued by the lower order harmonics, the major ones being the lower order harmonics. Appropriate L filters are designed in order to filter out the harmonic components from the current and thus making them sinusoidal. The design of the L filters can be done according to the formula

$$L = \frac{V_{dc}}{I_{rated} \Delta_{ripple} f_{sw}} (1 - m_a) m_a$$

Where

I_{rated} is the rated utility current,

Δ_{ripple} is maximum ripple magnitude percentage (5 % - 25 %),

V_{dc} is the DC link voltage,

L is the total filter inductance,

f_{sw} is the switching frequency (in Hz) and m_a is the modulation index.

3) Power control

We use the feedback from the grid in order to generate the current reference. The advantage of dynamic VAR systems is that they detect and instantaneously compensate for voltage disturbances by injecting leading or lagging reactive power at crucial junctures to the power transmission grids. Through the dynamic VAR control system, reactive power is supplied in the grid with fast dynamics. Thus it helps in regulating the system voltage and stabilizing the grid

It can be seen that the d-component and the q-component are highly coupled which leads to the degradation of the dynamic performance. The vector controller decouples these terms and thus providing the ability to control each current component independently.

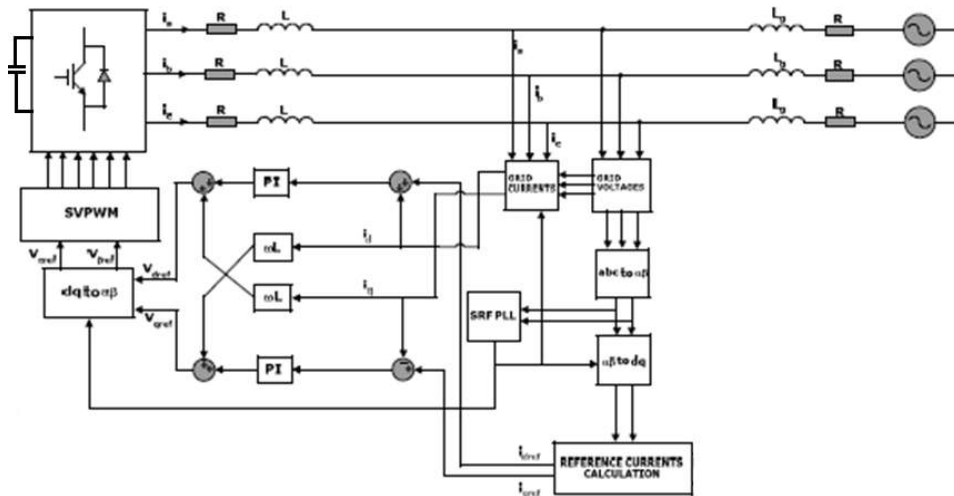

Fig. 3 Schematic diagram for the Grid Connected Inverter with its control

The elementary principle of the vector oriented control method is to control the instantaneous active and reactive grid power which can be done by controlling the grid currents, by separate controllers independent of each other. Two current controllers are employed namely d-current controller and q-current controller. The grid voltages and currents are first sensed and with the help of Synchronous Reference Frame (SRF) Phase Locked Loop, the grid phase angle is detected in order to synchronize the GCI output with grid. The demanded amount of current and voltage are then estimated from the grid at the desired power factor and the reference currents in a synchronous frame are calculated.

Consequently, the current controllers try to reduce the error and make the load currents follow the reference current vector. Thus we try to control the current and therefore controlling the inherent power flow. So by this process, the active and reactive powers are meticulously controlled. The converter DC voltage is determined by:

$$V_{dc}(t) = \frac{1}{C} \int [I_{dc}(t) - I_i(t)] dt \quad (22)$$

The DC voltage can be regulated using PI controller by choosing the current reference

$$I_{dc\text{ref}}(t) = K_p^v [V_{dc\text{ref}} - V_{dc}(t)] + K_i \int [V_{dc\text{ref}} - V_{dc}(t)] dt \quad (23)$$

Where $V_{dc\text{ref}}$ is the reference DC link voltage, K_p and K_i are the constant gains of the PI controller. The reference currents can be given by:

$$i_{d\text{ref}}(t) = \frac{2}{3\alpha} [U_d(t)P_{\text{ref}}(t) + U_q(t)Q_{\text{ref}}(t)] \quad (24)$$

$$i_{q\text{ref}}(t) = \frac{2}{3\alpha} [U_q(t)P_{\text{ref}}(t) - U_d(t)Q_{\text{ref}}(t)] \quad (25)$$

Where,

$$\alpha = U_d^2 + U_q^2 \quad (26)$$

Now,

$$v_{d\text{ref}}(t) = e_d(t) - U_d - Ri_d(t) + Li_q(t) \quad (27)$$

$$v_{q\text{ref}}(t) = e_q(t) - U_q - Ri_q(t) + Li_d(t) \quad (28)$$

where $v(t)_{dref}$ and $v(t)_{qref}$ are the d and q voltage references.

U_d and U_q are the effective voltage references.

$$U_d = K_p [i_{dref}(t) - i_d(t)] + K_i \int [i_{dref}(t) - i_d(t)] dt \quad (29)$$

$$U_q = K_p [i_{qref}(t) - i_q(t)] + K_i \int [i_{qref}(t) - i_q(t)] dt \quad (30)$$

Where K_p and K_i are the constant gains of the PI controller.

Simulation and Results

To validate the MRF PI current controller for Grid Connected Inverter (GCI), extensive computer simulations were performed using MATLAB. Under distorted and undistorted conditions, the detailed switching model of the space vector modulated (SVPWM) grid connected inverter has been developed.

The values of the gains K_p and K_i are calculated according to the formulae [10]:

$$K_p = \tau \cdot \frac{f_{sw}}{V_{dc}}$$

$$K_i = \frac{\tau f_{sw}^2}{2V_{dc}}$$

Where,

L/R are grid time constant;

L is the coupling inductance between the GCI and the grid,

R is the coupling resistance

V_{dc} is the dc-link voltage in p.u.

f_{sw} is the switching frequency.

The values of the gains K_p and K_i of the MRF PI controller are calculated according to the formulae [12]

$$K_p = \frac{4\tau}{3T_{sw}V_{dc}}$$

$$K_i = K_p / \tau_i$$

The system parameters used in the simulations are given in the Table-1

Table 1: Parameters used in simulation.

Parameter	Label	Value
Coupling inductance	L	7.52[mH]
Coupling resistance	R	0.26[Ω]
Grid voltage	V	240[V]
DC link voltage	V_{dc}	580[V]
Switching frequency	f_{sw}	5000[Hz]
Base voltage	V_b	964[V]
Base current	I_b	7.84[A]

a. Current control strategy

In order to authenticate the MRF PI controller we take three different conditions of the grid. The first case investigates the operation under voltage sag conditions and the second case for voltage swell conditions. Next

the grid voltages and currents under line to ground fault conditions were analysed and finally we observe the GCI operation under injection of non-sinusoidal grid voltages. The MRF PI current controller is basically focused on the mitigation of harmonics in the converter phase currents. However, it also shows considerable improvement in other unbalanced conditions. The comparative study regarding the presence of harmonics is analysed in detail here.

1) Voltage sag

The voltage sag conditions are employed with the help of a three phase programmable AC source in Simulink environment as shown in Fig. 4. The frequency was maintained at 50 Hz. Voltage amplitude was maintained at 0.2468 p.u. The sag is forced at 0.03 sec and maintained up to 0.05 sec. Fig 5. The reference d-current is taken as a step input and the reference q current was maintained at zero. SRF PLL is used for the detection of phase such that the d component of the grid voltage is maintained at phase voltage and the q component is maintained at zero.

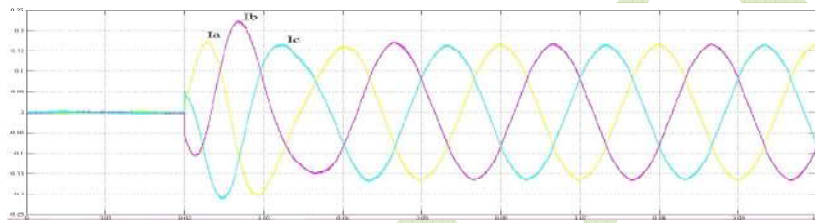

Figure 4: Converter current to grid during voltage sag condition

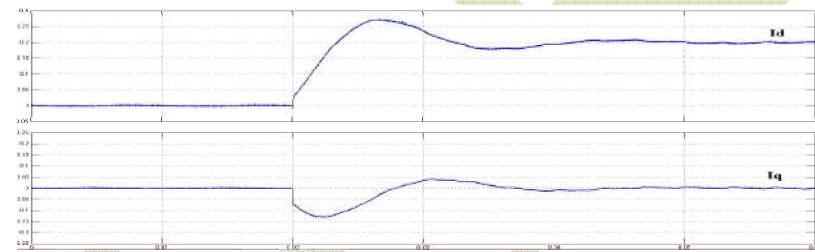

Figure 5: Id /Iq current component converter response during voltage sag Condition

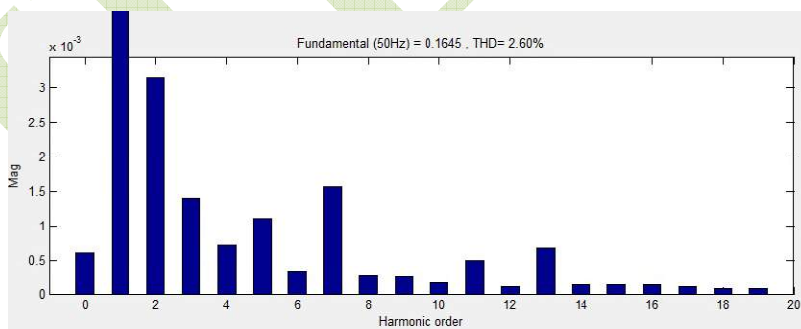

Figure 6: Harmonic spectrum of grid current with MRF PI controller for voltage sag

2) Voltage swell condition

Converter current to grid during voltage swell condition with the use of MRF PI is shown in Fig. 7 while Id and Iq components of the current is shown in Fig. 8. In Fig. 9. it is shown that there is substantial decrease in THD % as it is upto 2.73%. Thus it can be noticed that use of MRF PI controller reduces total harmonic distortion during voltage swell as well.

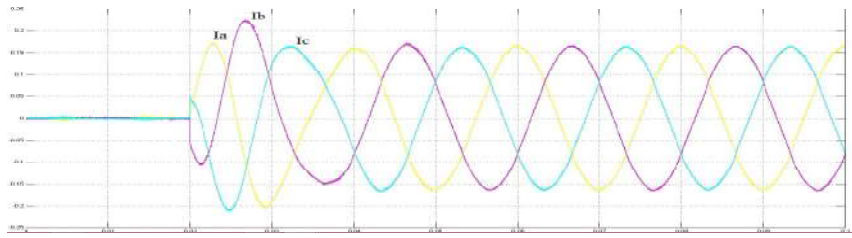

Figure 7: Converter current to grid during voltage swell condition

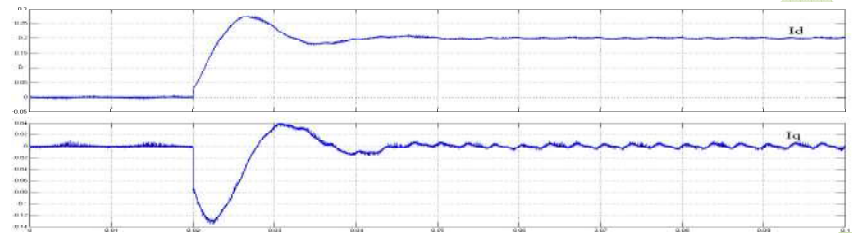

Figure 8: Id / Iq current component converter response during voltage swell condition

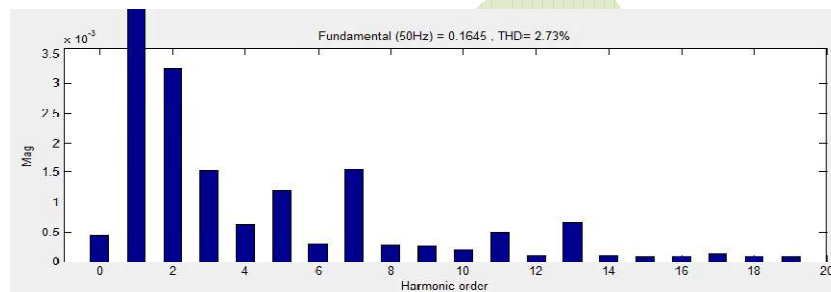

Figure 9: Harmonic spectrum of grid current under presence of MRF PI controller for voltage swell condition

3) Line-to-ground (LG) fault

The line-to-ground fault was created with the help of a three phase programmable AC source same as shown in Fig. 10. Converter current to grid during LG fault condition with the use of MRF PI is shown in Fig. 10 while Id and Iq components of the current is shown in Fig. 11.

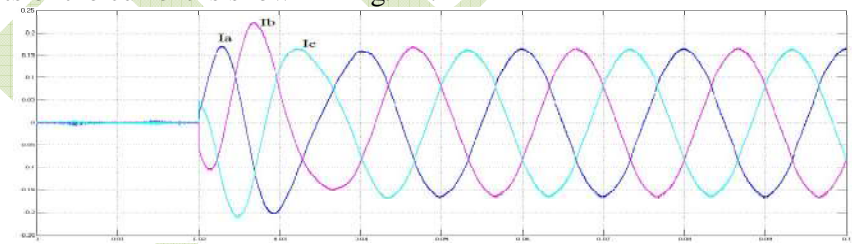

Figure 10: Converter current to grid during LG fault condition in phase A

In Fig. 12 it is shown that there is substantial decrease in THD % as it is upto 2.61%. Thus it can be noticed that use of MRF PI controller reduces total harmonic distortion during LG fault. Similarly results were observed for fault conditions in phase B and phase C.

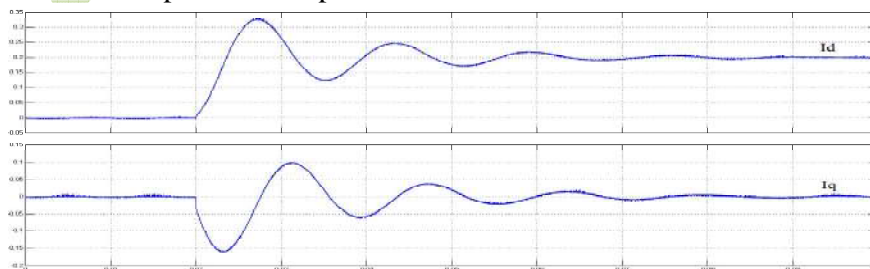

Figure 11: Id / Iq current component converter response during LG fault condition in phase A

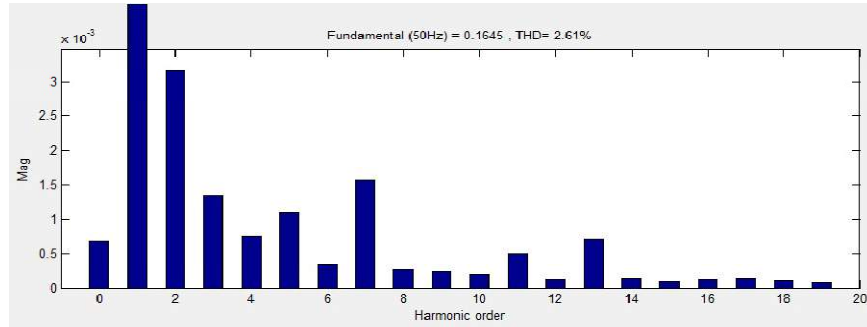

Figure 12: Harmonic spectrum of grid current during LG fault condition in phase A

4) Without L Filter

The behaviour of the converter without the presence of filter is observed for converter current and its Id/Iq components in Fig. 13 and Fig. 14. Here we consider the presence of MRF PI Controller which considerable improves the THD%.

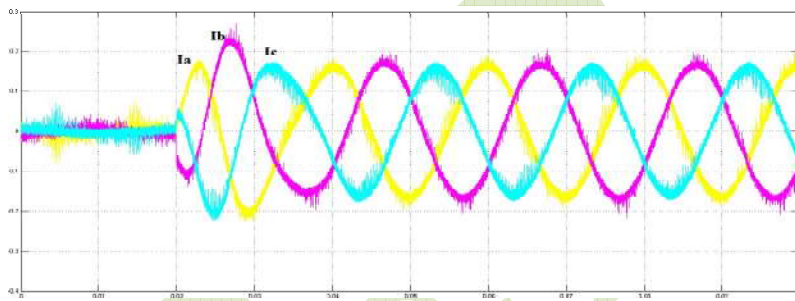

Figure 13: Converter current response to the grid without filter.

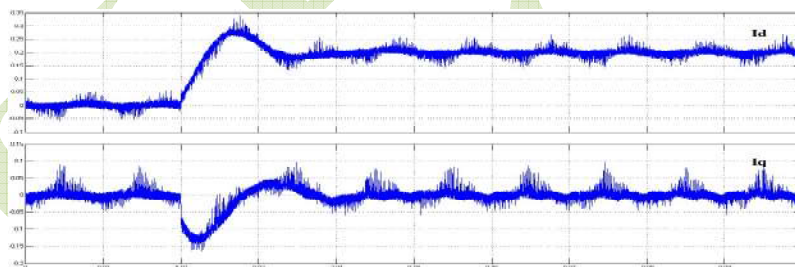

Figure 14: Id / Iq current component without Filter

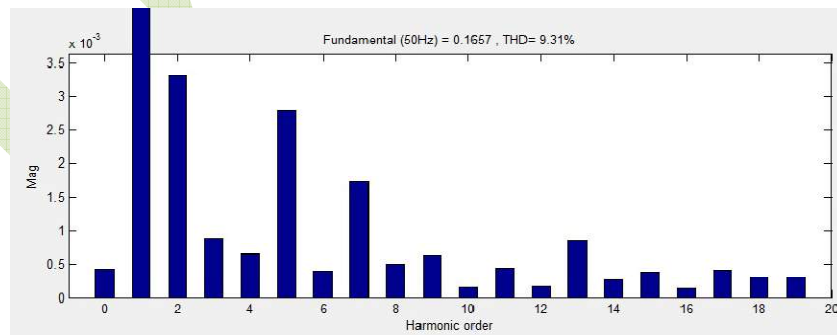

Figure 15: Harmonic spectrum of grid current under MRF PI without filter.

Conclusion

An improved current harmonics compensation capability through the use of Multi Reference Frame PI controller has been achieved in this paper. The performance of the system without filter is also studied. Also the Total Harmonic Distortion (THD) % for different conditions of the grid was observed. With the use of MRF PI Controller a reduction was seen in THD. Comparative studies have shown that the MRF PI controller provides better performance in terms of improvement of grid dynamics as compared to the conventional controller.

References

- [1] C.V.Dobariya, S.A.Khaparde, "Decoupled Power Controller for Inverter-interfaced Distributed Generation System," *IEEE Power Engineering Society General Meeting, 2007*, vol., no., pp.1-6, 24-28 June 2007
- [2] F.Blaabjerg, R. Teodorescu, M. Liserre, A.V.Timbus, , "Overview of Control and Grid Synchronization for Distributed Power Generation Systems," *IEEE Transactions on Industrial Electronics*, , vol.53, no.5, pp.1398-1409, Oct. 2006
- [3] M. Prodanovic, T.C. Green, , "Control and filter design of three-phase inverters for high power quality grid connection," *IEEE Transactions on Power Electronics*, vol.18, no.1, pp. 373- 380, Jan 2003
- [4] A. Anurag and B. C. Babu. Control of grid connected inverter system for sinusoidal current injection with improved performance. In Proc. 2012 IEEE Students' Conference on Engineering and Systems, pages 1{6, 16-18 March 2012.
- [5] C.Wessels J. Dannehl and F. Fuchs. Limitations of voltage-oriented pi current control of grid-connected pwm rectifiers with filters. *IEEE Trans. Ind. Electron*, 56(2):380{388, Feb 2009.
- [6] E.M.Adzic, D.P.Marcetic, V.A.Katic, V.A.; M.S. Dzic, "Grid-connected Voltage Source Converter operation under distorted grid voltage," *2010 14th International Power Electronics and Motion Control Conference (EPE/PEMC)*, vol., no., pp.T11-44-T11-51, 6-8 Sept. 2010.
- [7] Hong-Seok Song; Kwanghee Nam; , "Dual current control scheme for PWM converter under unbalanced input voltage conditions," *IEEE Transactions on Industrial Electronics*, vol.46, no.5, pp.953-959, Oct 1999.
- [8] G.Sinha T. C Y. Wang, Z.Ye and X. Yuan. Output filter design for a grid- interconnected three-phase inverter. *Conference Records on PESC'03*, 2:779 784, June 2003.
- [9] Jae-Seok Noh and Jaeho Choi. Design of voltage source pwm converter with ac input lcl filter. *Journal of Power Electronics*, The Korean Institute of Power Electronics, 7(5):490{498, Oct 2002.
- [10] T.C.Y.Wang and Xiaoming Yuan. Design of multiple-reference frame pi controller for power converters. *Proc. of 2004 IEEE 35th Annual Power Electronics Specialists Conference*, 5:3331{3335, June 2004.